

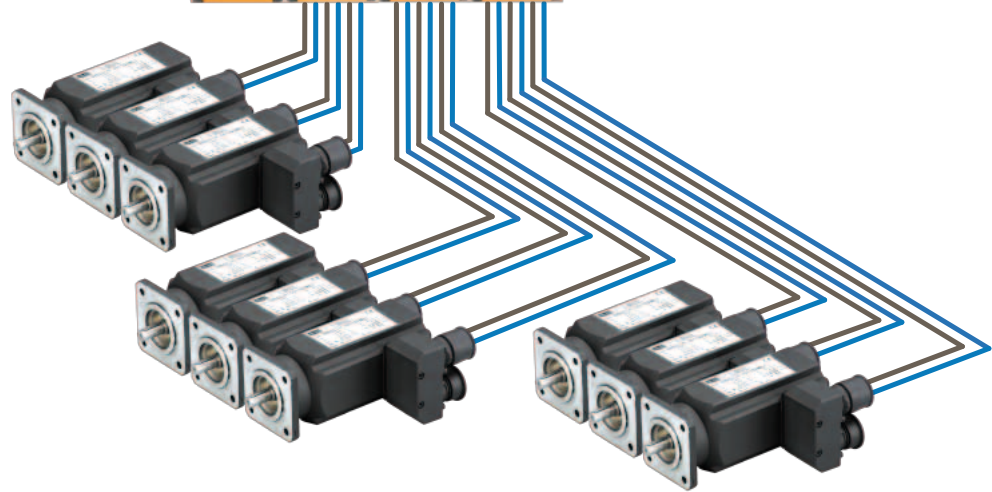

aerospace
climate control
electromechanical
filtration
fluid & gas handling
hydraulics
pneumatics
process control
sealing & shielding

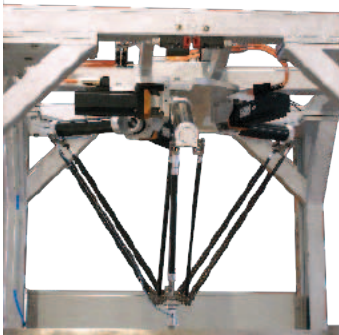

TPD-M

Triple Axis Servo Drive System



ENGINEERING YOUR SUCCESS.



WARNING – USER RESPONSIBILITY

FAILURE OR IMPROPER SELECTION OR IMPROPER USE OF THE PRODUCTS DESCRIBED HEREIN OR RELATED ITEMS CAN CAUSE DEATH, PERSONAL INJURY AND PROPERTY DAMAGE.

- This document and other information from Parker-Hannifin Corporation, its subsidiaries and authorized distributors provide product or system options for further investigation by users having technical expertise.
- The user, through its own analysis and testing, is solely responsible for making the final selection of the system and components and assuring that all performance, endurance, maintenance, safety and warning requirements of the application are met. The user must analyze all aspects of the application, follow applicable industry standards, and follow the information concerning the product in the current product catalog and in any other materials provided from Parker or its subsidiaries or authorized distributors.
- To the extent that Parker or its subsidiaries or authorized distributors provide component or system options based upon data or specifications provided by the user, the user is responsible for determining that such data and specifications are suitable and sufficient for all applications and reasonably foreseeable uses of the components or systems.

Overview	5
Technical Characteristics.....	8
Technical Data.....	8
Environmental Characteristics.....	8
TPD-M Features.....	9
Standards & Conformance	10
Dimensions	10
Connector Layout.....	10
Accessories and Options	11
Hiperface DSL® Feedback.....	11
Configuration Software - MotionWiz.....	12
Parker Solutions for Servomotors and Accessories	13
NX: Brushless servo motors.....	13
SMB/H-MB/H: Brushless servo motors.....	13
Interact Xpress: HMI	13
PIO: I/O System	13
PS/RS Series: Planetary Gearheads	13
Order Code.....	14
TPD-M System	14
Mains module: PSUP	14

Parker Hannifin

The global leader in motion and control technologies

A world class player on a local stage

Global Product Design

Parker Hannifin has more than 40 years experience in the design and manufacturing of drives, controls, motors and mechanical products. With dedicated global product development teams, Parker draws on industry-leading technological leadership and experience from engineering teams in Europe, North America and Asia.

Local Application Expertise

Parker has local engineering resources committed to adapting and applying our current products and technologies to best fit our customers' needs.

Manufacturing to Meet Our Customers' Needs

Parker is committed to meeting the increasing service demands that our customers require to succeed in the global industrial market. Parker's manufacturing teams seek continuous improvement through the implementation of lean manufacturing methods throughout the process. We measure ourselves on meeting our customers' expectations of quality and delivery, not just our own. In order to meet these expectations, Parker operates and continues to invest in our manufacturing facilities in Europe, North America and Asia.

Electromechanical Worldwide Manufacturing Locations

Europe

Littlehampton, United Kingdom
Dijon, France
Offenburg, Germany
Filderstadt, Germany
Milan, Italy

Asia

Wuxi, China
Chennai, India

North America

Rohnert Park, California
Irwin, Pennsylvania
Charlotte, North Carolina
New Ulm, Minnesota



Offenburg, Germany

Local Manufacturing and Support in Europe

Parker provides sales assistance and local technical support through a network of dedicated sales teams and authorized technical distributors throughout Europe.

For contact information, please refer to the Sales Offices on the back cover of this document or visit www.parker.com



Milan, Italy



Littlehampton, UK

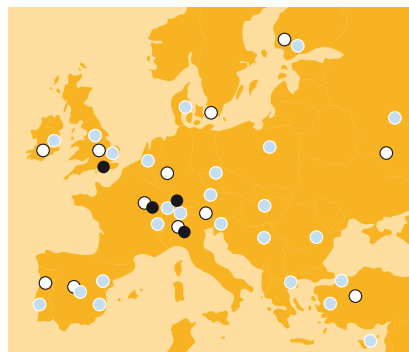

- Electromechanical Manufacturing
- Parker Sales Offices
- Distributors



Dijon, France

Triple Axis Servo Drive - TPD-M

Overview

Description

TPD-M is a multi axis system where each power module can supply up to three servo motors. The base configuration consists of a common DC bus supply (PSU) and multiples TPD-M modules, connected through DC bus bars.

The modules are available as one, two or three axis versions. This makes the system very flexible.

The TPD-M drive has been specifically designed for the Packaging OEM market but it can also be used in many other centralized automation structures which incorporate a large number of servo axes offering significant advantages.

TPD-M controls also induction motors with feedback or sensorless in V/f mode.

- Packaging machines
- Material forming machines
- Textile machines
- Paper and converting lines
- Plastics machines
- Machines tools

Motion control functionality is performed by means of EtherCAT Real Time CoE (CAN over Ethernet) communication, CAN / CANopen DS402 communication.

Features

- The most compact multi-axis servo drive on the market
- Quick and simple wiring
- One, two or three axis versions combined in one housing
- Removable SD card
- Common DC bus connection for energy exchange between drives
- Feedback: Resolver, Hiperface and EnDat interface, Hall sensors, rotary and linear encoders
- New feedback: Hiperface DSL feedback ®
Reduced cabling; only one cable connection between drive & motor
- Fieldbus: CANopen - standard, EtherCAT - option
- Serial link and CAN auto-address



Technical characteristics - Overview

TPD Axis	Continuous current [A _{rms}]	Peak current A (≤ 2 s)
3 axis	2 + 2 + 2	4 + 4 + 4
	8 + 5 + 5	16 + 10 + 10
2 axis	2 + 2	4 + 4
	5 + 5	10 + 10
	8 + 8	16 + 16
	15 + 5	30 + 10
1 axis	5/10/15/30	10/20/30/60

TPD-M Overview

TPD-M has been developed for all applications where multiple drives are normally used and gives both OEMs and end users the opportunity to reduce build, configuration and operating costs, while boosting productivity and profitability.

Typical applications for TPD-M include packaging machines, material forming machines, textile, paper, converting and plastics machines, where large numbers of axes are required.

Features and Benefits

Control cabinet space, size and cost savings

The integration of three servo power stages in a single housing offers machine builders the opportunity of having more compact control cabinets. Each TPD-M module is only 50 mm width (100 mm in the single axis 30 A version).

Reduced system complexity

The complexity of the system is significantly reduced due to the following benefits:

- Fewer components (cables, connectors, filters and braking resistors)
- Fewer communication interconnections between devices
- Centralized filtration and braking resistance

Reduce setup and maintenance costs

Due to the modular nature of TPD-M, machine design is much more straight forward. Additional axes can be added easily, simply by reproducing schemes from other existing axes. Programming time is reduced as only one drive unit needs to be configured.

Efficient power control

TPD-M works on a common DC bus power supply that allows the system to absorb and re-supply much of the braking energy to other TPD-M units rather than dissipating it in the form of heat via external resistors. In some instances, resistors can be removed completely and in others smaller resistors are required.

Standard Version

TPD-M servo drives is available as one, two or three axis versions. As standard TPD-M is supplied with:

- CANopen
- STO functionality
- Digital and analog inputs/outputs
- Mechanical brake control

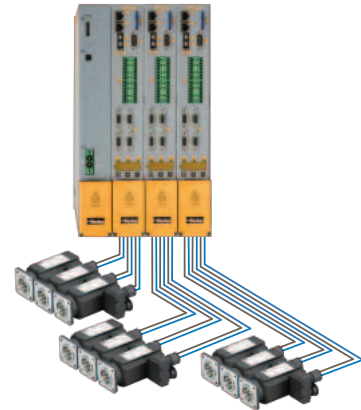

TPD-M system with Parker servo motors

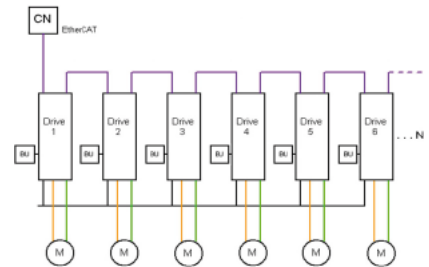

Traditional solution: one drive for each axis

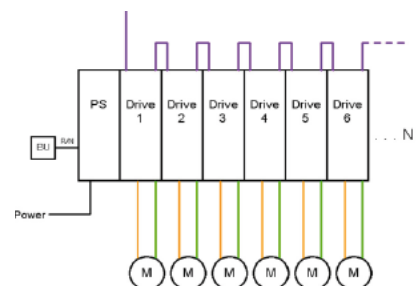

Rack solution: one drive for each axes in a rack solution

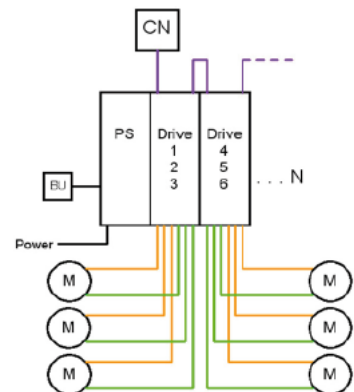

TPD-M solution: one drive for three axis in a rack solution. Only one Power Supply

TPD-M Overview

Application

TPD-M servo drive is particularly suitable for all centralised automation systems, such as those found in many packaging machines, where large numbers of drives are often required.

- Packaging lines
- Material forming machines
- Textile machines
- Paper and converting lines
- Plastics machines
- Machine tools



Functionality

Additional features of TPD-M include an USB interface for configuration and setup plus a standard SD card interface for storing system parameters.

TPD-M can be integrated into a larger hybrid motion solution (centralized and decentralized) using Parker Motornet DC system.



Options

The capabilities of TPD-M can be further enhanced with numerous options which are available upon request, including:

- EtherCAT communication
- Hiperface DSL® feedback
- Braking resistors
- Additional inputs/outputs



Safety technology

TPD-M supports the "Safe Torque Off" (STO) safety function in the sense of the "Safe Stop", with protection against unexpected startup according to the requirements EN ISO 13849-1 Category 3.

Together with the external safety control device, the "safe stop 1" (SS1) safety function according to the requirements of EN ISO 13849-1 category 3 can be used.

Switching off the motor torque must be effected by the machine controller.

According to a risk analysis which must be carried out according to the machine standard 89/392/EWG or EN 292; EN ISO 13849-1 and EN 1050, the machine manufacturer must project the safety system for the entire machine including all integrated components. This does also include the electrical drives.

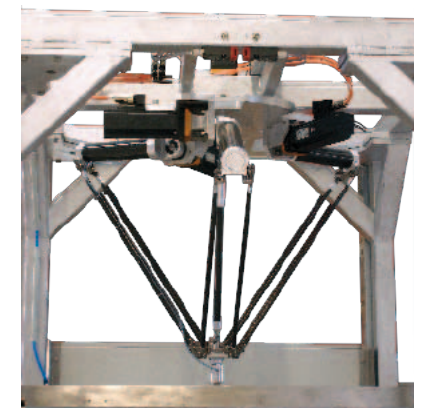

Technical Characteristics

Technical Data

Type	3 axis	
	Unit	
Rated Output Current	[A _{rms}]	2 + 2 + 2 8 + 5 + 5
Peak Output Current (≤ 2 s)	[A]	4 + 4 + 4 16 + 10 + 10
Maximum Continuous Module Output Current	[A]	6 16 ⁽¹⁾
Maximum DC Voltage Supply		750 VDC

⁽¹⁾ The max continuous module current is clamped to 16 A

Type	Unit	2 axis				1 axis			
		2 + 2	5 + 5	8 + 8	5 + 15	5	10	15	30
Rated Output Current	[A _{rms}]	2 + 2	5 + 5	8 + 8	5 + 15	5	10	15	30
Peak Output Current (≤ 2 s)	[A]	4 + 4	10 + 10	16 + 16	10 + 30	10	20	30	60
Maximum Continuous Module Output Current	[A]	4	10	16	30	5	10	15	30
Maximum DC Voltage Supply		750 VDC							

PSUP - Power Supply Unit

Mains Supply

Power Supply Type	Unit	PSUP10			PSUP20			PSUP30 ⁽²⁾		
Input Voltage		3*230 ... 480 VAC ±10 % 50...60 Hz (Rated voltage 3*400 VAC)								
Output Voltage		325...680 VDC ±10 %								
Supplied Voltage	[VAC]	230	400	480	230	400	480	230	400	480
Output Power	[kVA]	6	10	10	12	20	20	18	30	30
Peak Output Power (<5 s)	[kVA]	12	20	20	24	40	40	34	60	60

Control Supply

Rated Input Voltage		24 VDC ±10 %								
Maximum Ripple		1 V _{pkpk}								
Supply Current	[A]	PSUP10D6: 0.2 A			PSUP20D6: 0.3 A			PSUP30D6: 0.3 A		

⁽²⁾ Operation of the PSUP30 only with line choke.

Environmental Characteristics

Type	TPD-M	PSUP
Operating Temperature	0...+40 °C	
Storage Temperature	-25 °C...+55 °C	
Shipping Temperature	-25 °C...+70 °C	
Product Enclosure Rating	IP20 (only in closed electrical cabinet) UL open type equipment	
Altitude	1000 m ASL. Derate output current by 1.5 % per 100 m to a maximum of 2000 m	
Operating Humidity	Class 3K3 - Maximum 85 % non-condensing	
Storage Humidity	Class 1K3 - Maximum 95 % non-condensing	
Shipping Humidity	Class 2K3 - Maximum 95 % at 40 °C	
Operating Vibration	IEC60068-2-6 10...57 Hz width 0.075 mm 57...150 Hz accel. 9.81 m/s ²	

TPD-M Features

Communication	<ul style="list-style-type: none"> • via USB port
Networks and Bus Systems	<ul style="list-style-type: none"> • CANopen, 20...1000kbit/s, SDO1, PDO1...PDO4 • EtherCAT, 100Mbit/s, 1 ms cycle time • Via Gateway <ul style="list-style-type: none"> • Profibus • DeviceNet
Inputs / Outputs	<ul style="list-style-type: none"> • 4 digital input, • 2 digital output, • 1 analog input • 1 analog output for each axes. • 1 incremental encoder input, • 1 incremental encoder output • Additional I/O <ul style="list-style-type: none"> • 3 analogue inputs 12bit, • 2 incremental encoder input, • 2 incremental encoder output • Auxiliary Encoder
Supported Feedback	<ul style="list-style-type: none"> • Resolver, • SinCos, • SinCos + EnDat, • SinCos + Hiperface, • SinCos (1 per pole pitch), • Quadrature, • Quadrature + Hall, • SinCos + Hall, • Hiperface DSL®
Programming / Configuration	<ul style="list-style-type: none"> • PicoPLC • MotionWiz with Oscilloscope function, real time and debugging features • Removable SD card for <ul style="list-style-type: none"> • software upgrade, • parameters and • application memory
Technology Functions	<ul style="list-style-type: none"> • Torque control • Speed control • Position control • Electronic gearbox • Camming
Safety Functions	<ul style="list-style-type: none"> • 1 Safety Torque Off circuit for 3 axis module • 2 independent Safety Torque Off circuit for 2 axis module • 1 Safety Torque Off circuit for 1 axis module

Standards & Conformance

2006/95/EC	Low voltage directive
EN 60204-1	Safety of machinery - Electrical equipment of machines - Part 1: General requirements
EN 61800-5-1	Adjustable speed electrical power drive systems - safety requirements, thermal and energy
UL508C	(USA) Power Conversion Equipment
2004/108/EC	EMC directive
EN 61800-3	Adjustable speed electrical power drive systems - Part 3: EMC product standard including specific test method

Dimensions

Type	W [mm]	D [mm]	Weight [kg]
TPD-M 1/2/3 axes	50	270	4.3
TPD-M single axis 30 A	100	270	8.6
PSUP10	50	270	3.6
PSUP20 / PSUP30	100	270	5.4

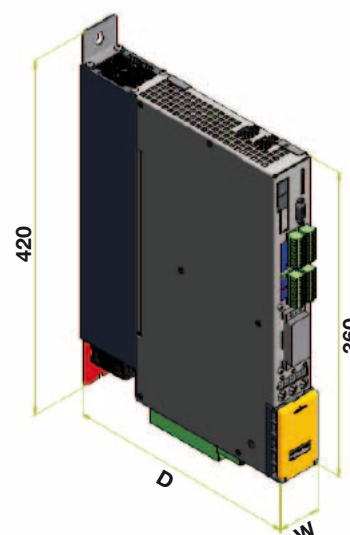

Connector Layout

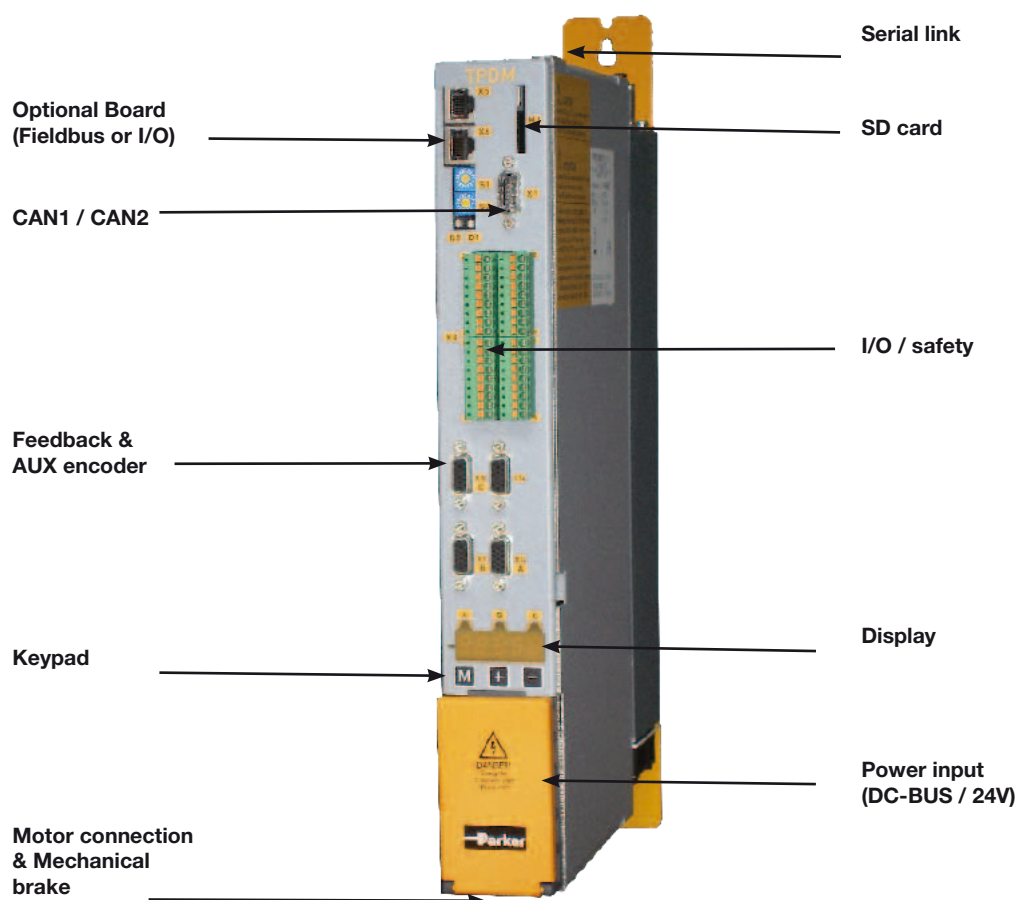

Accessories and Options

Hiperface DSL® Feedback

Description

The Single Cable Servo Drive System from Parker is a combination of the low inertia servo motor SME and the triple axis servo drive TPD-M based on the Hiperface DSL® digital feedback technology. The encoder feedback communication is fully integrated into the motor power cable and thus no separate feedback cable between drive and motor is required.

The new feedback system is a purely digital encoder communication protocol with exceptional performance. The absolute position determination, a resolution of up to 20 bit per turn, as well as 4096 maximum rotations, is unique in it's class.

The System is completed by the multi-axis servo drive TPD-M which represents one of the most compact solutions on the market giving the possibility of controlling up to three single cable SME servo motors with one 50 mm drive module.

Therefore, the Single Cable Servo Drive System from Parker is a bespoke solution to provide machine builders with lower cabling and installation cost and the possibility to reduce control panel size and machine footprint.



TPD-M triple axis servo drive connected to SME motors via Hiperface DSL® interface: One cable per servo motor instead of two.

Feedback-Features

- **One cable connection between drive and motor instead of two**
- **No need for separate feedback cable and connector**
- **Fully digital and interference-free communication**
- **Synchronous, bidirectional, multi-channel**
- **Easy setup and reduced wiring**

Applications

- **Packaging Machinery**
- **Material Handling**
- **Machine Tools**
- **Robotics**
- **Paper & Converting**

Configuration Software - MotionWiz

MotionWiz is free of charge downloadable configuration software that allows users to configure and optimise the TPD-M series with a few easy clicks of the mouse.

MotionWiz features an intuitive, easy and simple to use Windows® style environment to aid installation, optimisation and diagnostic use.

MotionWiz permits operation in both “on line” mode, directly in the controller, and in “offline” mode, remotely on the PC before downloading to the controller.

To simplify the configuration of systems with a large number of similar axes but with different motion profiles, MotionWiz allows users to copy the configuration from one application to another.

Inside the MotionWiz configurator is a database containing the technical characteristics of the full range of Parker motors and drives.

MotionWiz can be downloaded at www.parker.com/eme/tpdm

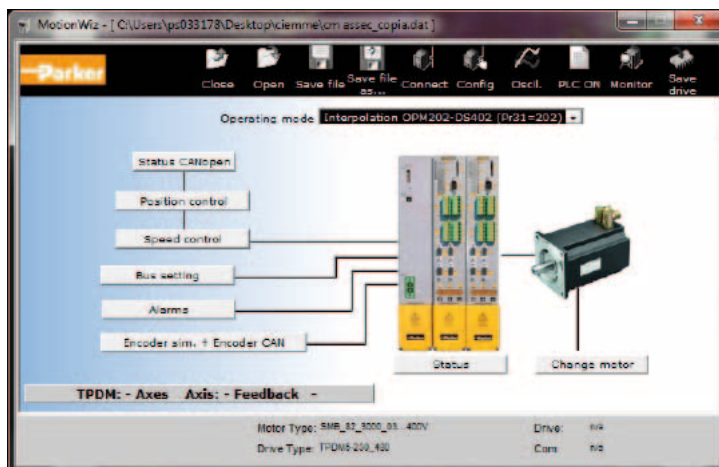

MotionWiz: General settings

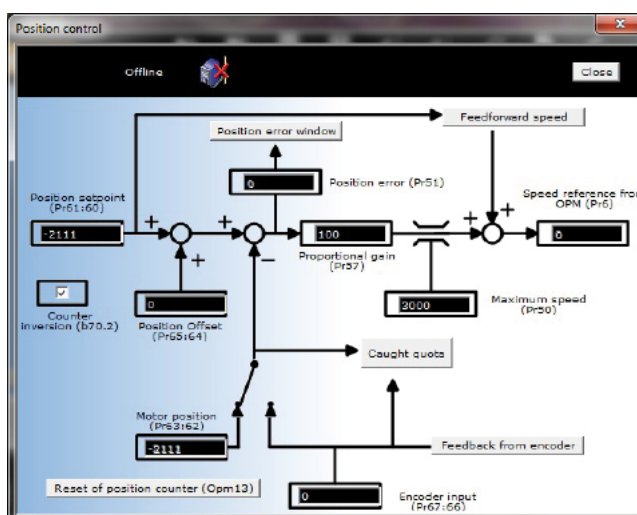

MotionWiz: Position control

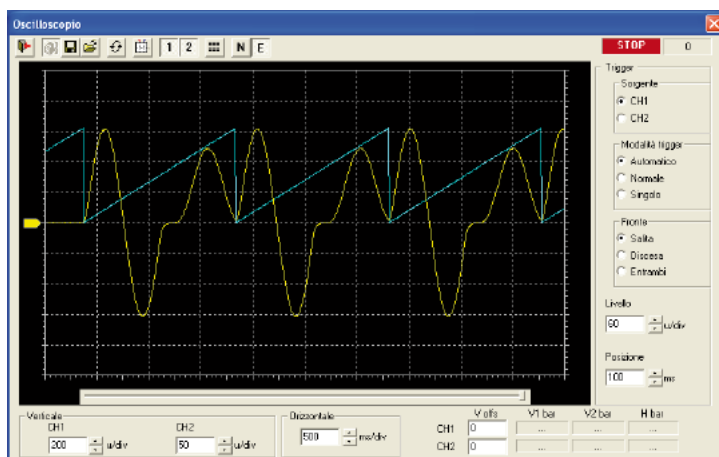

MotionWiz Oscilloscope: Real speed & torque trends

Parker Solutions for Servomotors and Accessories

NX: Brushless servo motors

The NX series brushless servo motors are characterized by a 10-pole innovative design for highest quality of motion, improved torque density and a compact and robust design. A large set of torque / speed characteristics, options and customization possibilities are available, making NX Series servomotors the ideal solution for most servosystems applications. The NX Series is available in sizes from 0,45 to 64 Nm.



SMB/H-MB/H: Brushless servo motors

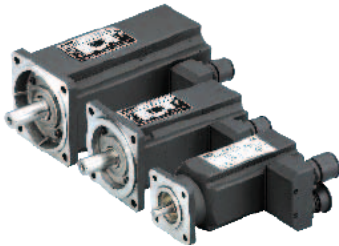

The MB/H and SMB/H Series of highly-dynamic brushless servo motors utilise "salient pole" technology to produce an extremely compact design. Motor dimensions are drastically reduced and significant gains in terms of torque and dynamic performance are achieved. The high quality Neodymium-Iron-Boron magnets and the encapsulation method used to fasten them to the shaft, allows the two Series' to achieve very high acceleration and withstand high overloads without risk of demagnetisation or detachment of the magnets. The MB/H and SMB/H Series is available in sizes from 0.2 to 285 Nm.

Interact Xpress: HMI

Interact Xpress is Parker's HMI hardware and software solution, for the process's control in distributed applications where multiple HMIs are deployed on a single machine or across several remote stations. Interact Xpress software, features an advanced development environment for easy creation of rich graphics and multimedia applications. Interact Xpress allows you to run, view and edit on line - from any PC -applications in Internet Explorer™ browser. Available with 6, 8,10 and 15 inch, these units are specifically designed to optimize the performance, storage and connectivity features of the software.



PIO: I/O System



Parker's PIO modular bus terminal system offers a range of popular industrial fieldbus networks to interface to a wide variety of control signals from field-based devices. Connection to field level devices can be implemented quickly and reliably with PIO.

PS/RS Series: Planetary Gearheads

Stealth advanced gearheads are available in either in-line or right-angled versions with 8 frame sizes and 12 gear ratios. With input speeds up to 6000 min⁻¹ and exceptionally quiet, strong and reliable operation, you can be confident that there is a Stealth advanced gearhead to fit any of your high performance servo application needs.



Order Code

TPD-M System

	1	2	3	4	5	6	7
Order example	TPD	M	02 02 02	D	L	E5	G

1 Drive Family	TPD	Triple Power Drive
2 Axes	M	Multi Axis
3 Drive Size	02 02 02	3 axis 2 A + 2 A + 2 A
	08 05 05	3 axis 8 A + 5 A + 5 A
	02 02	2 axis 2 A + 2 A
	05 05	2 axis 5 A + 5 A
	08 08	2 axis 8 A + 8 A
	15 05	2 axis 15 A + 5 A
	5	single axis 5 A
	10	single axis 10 A
	15	single axis 15 A
	30	single axis 30 A
4 Fieldbus	D	CANopen
5 Feedback system	Empty field	Resolver
	E	EnDat / Incremental / SinCos encoder
	H	Incremental encoder + Hall sensors
	L	DSL feedback
6 Option board	Empty field	No option
	E5	EtherCAT option board
	E7	Analogic expansion board
7 Accessories	G	Fixing shield

Mains module: PSUP

	1	2	3	4	5
Order example	PSU	P	10	D6	USB M00

1 Device family	PSU	Power module
2 Device typ	P	Power module
3 Nominal power; supply voltage	10 D6	10 kW; 400 VAC (3-phase)
	20 D6	20 kW; 400 VAC (3-phase)
	30 D6	30 kW; 400 VAC (3-phase) ¹⁾
4 Interface	USB	USB connection
5 Options	M00	no additional supplement

¹⁾ Operation of the PSUP30 only with line choke.
Required line choke for the PSUP30: 0.45 mH / 55 A

We offer the following line chokes:

LCG-0055-0.45 mH (WxDxH: 180 mmx140 mmx157 mm; 10 kg)
LCG-0055-0.45 mH-UL (with UL certification)
(WxDxH: 180 mmx170 mmx157 mm; 15 kg)

Capacitor module

	1	2
Order example	PSC	023 M00

1 Accessories	PSC	Capacitor module
2 Type	023 M00	23 µF no additional supplement
	047 M00	47 µF no additional supplement
	068 M00	68 µF no additional supplement

Mains filter for PSUP

	1	2
Order example	NFI	03/01

1 Accessories	NFI	Mains filter
2 Type	03/01	for PSUP10 Reference axis combination 3 x 480 V 25 A 6 x 10 m motor cable length
	03/02	for PSUP10 Reference axis combination 3 x 480 V 25 A 6 x 50 m motor cable length
	03/03	for PSUP20, PSUP30 Reference axis combination 3 x 480 V 50 A 6 x 50 m motor cable length

Braking resistors

	1	2
Order example	BRM	05/01

1 Accessories	BRM	Braking resistor
2 Type	13/01	30 Ω / 0.5 kW _{cont.} for PSUP10D6, for PSUP20D6 (2x30Ω parallel)
	14/01	15 Ω / 0.5 kW _{cont.} for PSUP10D6 (2 x 15 Ω in series) for PSUP20, PSUP30
	12/01	18 Ω / 4.5 kW _{cont.} for PSUP30

Motor output choke

For disturbance suppression when the motor connecting cables are long.

	1	2
Order example	MDR	01/04

1 Accessories	MDR	Motor output choke (for TPD-M >20 m motor cable)
2 Type	01/01	up to 16 A rated motor current
	01/02	up to 30 A rated motor current
	01/04	up to 6.3 A rated motor current

Other Accessories

Order Code	Description
Motionwiz	Programming Software
Exp-Ground	Fixing shield assembly
USBTODRIVE	USB to RS232/422 converter with cable

Parker's Motion & Control Technologies

At Parker, we're guided by a relentless drive to help our customers become more productive and achieve higher levels of profitability by engineering the best systems for their requirements. It means looking at customer applications from many angles to find new ways to create value. Whatever the motion and control technology need, Parker has the experience, breadth of product and global reach to consistently deliver. No company knows more about motion and control technology than Parker. For further info call 00800 27 27 5374.



AEROSPACE

Key Markets

- Aircraft engines
- Business & general aviation
- Commercial transports
- Land-based weapons systems
- Military aircraft
- Missiles & launch vehicles
- Regional transports
- Unmanned aerial vehicles

Key Products

- Flight control systems & components
- Fluid conveyance systems
- Fluid metering delivery & atomization devices
- Fuel systems & components
- Hydraulic systems & components
- Inert nitrogen generating systems
- Pneumatic systems & components
- Wheels & brakes



CLIMATE CONTROL

Key Markets

- Agriculture
- Air conditioning
- Food, beverage & dairy
- Life sciences & medical
- Precision cooling
- Processing
- Transportation

Key Products

- CO² controls
- Electronic controllers
- Filter driers
- Hand shut-off valves
- Hose & fittings
- Pressure regulating valves
- Refrigerant distributors
- Safety relief valves
- Solenoid valves
- Thermostatic expansion valves



ELECTROMECHANICAL

Key Markets

- Aerospace
- Factory automation
- Food & beverage
- Life science & medical
- Machine tools
- Packaging machinery
- Paper machinery
- Plastics machinery & converting
- Primary metals
- Semiconductor & electronics
- Textile
- Wire & cable

Key Products

- AC/DC drives & systems
- Electric actuators
- Controllers
- Gantry robots
- Gearheads
- Human machine interfaces
- Industrial PCs
- Inverters
- Linear motors, slides and stages
- Precision stages
- Stepper motors
- Servo motors, drives & controls
- Structural extrusions



FILTRATION

Key Markets

- Food & beverage
- Industrial machinery
- Life sciences
- Marine
- Mobile equipment
- Oil & gas
- Power generation
- Process
- Transportation

Key Products

- Analytical gas generators
- Compressed air & gas filters
- Condition monitoring
- Engine air, fuel & oil filtration & systems
- Hydraulic, lubrication & coolant filters
- Process, chemical, water & microfiltration filters
- Nitrogen, hydrogen & zero air generators



FLUID & GAS HANDLING

Key Markets

- Aerospace
- Agriculture
- Bulk chemical handling
- Construction machinery
- Food & beverage
- Fuel & gas delivery
- Industrial machinery
- Mobile
- Oil & gas
- Transportation
- Welding

Key Products

- Brass fittings & valves
- Diagnostic equipment
- Fluid conveyance systems
- Industrial hose
- PTFE & PFA hose, tubing & plastic fittings
- Rubber & thermoplastic hose & couplings
- Tube fittings & adapters
- Quick disconnects



HYDRAULICS

Key Markets

- Aerospace
- Aerial lift
- Agriculture
- Construction machinery
- Forestry
- Industrial machinery
- Mining
- Oil & gas
- Power generation & energy
- Truck hydraulics

Key Products

- Diagnostic equipment
- Hydraulic cylinders & accumulators
- Hydraulic motors & pumps
- Hydraulic systems
- Hydraulic valves & controls
- Power take-offs
- Rubber & thermoplastic hose & couplings
- Tube fittings & adapters
- Quick disconnects



PNEUMATICS

Key Markets

- Aerospace
- Conveyor & material handling
- Factory automation
- Food & beverage
- Life science & medical
- Machine tools
- Packaging machinery
- Transportation & automotive

Key Products

- Air preparation
- Compact cylinders
- Field bus valve systems
- Grippers
- Guided cylinders
- Manifolds
- Miniature fluidics
- Pneumatic accessories
- Pneumatic actuators & grippers
- Pneumatic valves and controls
- Rodless cylinders
- Rotary actuators
- Tie rod cylinders
- Vacuum generators, cups & sensors



PROCESS CONTROL

Key Markets

- Chemical & refining
- Food, beverage & dairy
- Medical & dental
- Microelectronics
- Oil & gas
- Power generation

Key Products

- Analytical sample conditioning products & systems
- Fluoropolymer chemical delivery fittings, valves & pumps
- High purity gas delivery fittings, valves & regulators
- Instrumentation fittings, valves & regulators
- Medium pressure fittings & valves
- Process control manifolds



SEALING & SHIELDING

Key Markets

- Aerospace
- Chemical processing
- Consumer
- Energy, oil & gas
- Fluid power
- General industrial
- Information technology
- Life sciences
- Military
- Semiconductor
- Telecommunications
- Transportation

Key Products

- Dynamic seals
- Elastomeric o-rings
- EMI shielding
- Extruded & precision-cut, fabricated elastomeric seals
- Homogeneous & inserted elastomeric shapes
- High temperature metal seals
- Metal & plastic retained composite seals
- Thermal management

Parker Worldwide

Europe, Middle East, Africa

AE – United Arab Emirates,
Dubai

Tel: +971 4 8127100
parker.me@parker.com

AT – Austria, Wiener Neustadt

Tel: +43 (0)2622 23501-0
parker.austria@parker.com

AT – Eastern Europe, Wiener
Neustadt

Tel: +43 (0)2622 23501 900
parker.easteurope@parker.com

AZ – Azerbaijan, Baku

Tel: +994 50 2233 458
parker.azerbaijan@parker.com

BE/LU – Belgium, Nivelles

Tel: +32 (0)67 280 900
parker.belgium@parker.com

BY – Belarus, Minsk

Tel: +375 17 209 9399
parker.belarus@parker.com

CH – Switzerland, Etoy

Tel: +41 (0)21 821 87 00
parker.switzerland@parker.com

CZ – Czech Republic, Klecany

Tel: +420 284 083 111
parker.czechrepublic@parker.com

DE – Germany, Kaarst

Tel: +49 (0)2131 4016 0
parker.germany@parker.com

DK – Denmark, Ballerup

Tel: +45 43 56 04 00
parker.denmark@parker.com

ES – Spain, Madrid

Tel: +34 902 330 001
parker.spain@parker.com

FI – Finland, Vantaa

Tel: +358 (0)20 753 2500
parker.finland@parker.com

FR – France, Contamine s/Arve

Tel: +33 (0)4 50 25 80 25
parker.france@parker.com

GR – Greece, Athens

Tel: +30 210 933 6450
parker.greece@parker.com

HU – Hungary, Budapest

Tel: +36 23 885 470
parker.hungary@parker.com

IE – Ireland, Dublin

Tel: +353 (0)1 466 6370
parker.ireland@parker.com

IT – Italy, Corsico (MI)

Tel: +39 02 45 19 21
parker.italy@parker.com

KZ – Kazakhstan, Almaty

Tel: +7 7272 505 800
parker.easteurope@parker.com

NL – The Netherlands, Oldenzaal

Tel: +31 (0)541 585 000
parker.nl@parker.com

NO – Norway, Asker

Tel: +47 66 75 34 00
parker.norway@parker.com

PL – Poland, Warsaw

Tel: +48 (0)22 573 24 00
parker.poland@parker.com

PT – Portugal, Leca da Palmeira

Tel: +351 22 999 7360
parker.portugal@parker.com

RO – Romania, Bucharest

Tel: +40 21 252 1382
parker.romania@parker.com

RU – Russia, Moscow

Tel: +7 495 645-2156
parker.russia@parker.com

SE – Sweden, Spånga

Tel: +46 (0)8 59 79 50 00
parker.sweden@parker.com

SK – Slovakia, Banská Bystrica

Tel: +421 484 162 252
parker.slovakia@parker.com

SL – Slovenia, Novo Mesto

Tel: +386 7 337 6650
parker.slovenia@parker.com

TR – Turkey, Istanbul

Tel: +90 216 4997081
parker.turkey@parker.com

UA – Ukraine, Kiev

Tel +380 44 494 2731
parker.ukraine@parker.com

UK – United Kingdom, Warwick

Tel: +44 (0)1926 317 878
parker.uk@parker.com

ZA – South Africa, Kempton Park

Tel: +27 (0)11 961 0700
parker.southafrica@parker.com

North America

CA – Canada, Milton, Ontario

Tel: +1 905 693 3000

US – USA, Cleveland

Tel: +1 216 896 3000

Asia Pacific

AU – Australia, Castle Hill

Tel: +61 (0)2-9634 7777

CN – China, Shanghai

Tel: +86 21 2899 5000

HK – Hong Kong

Tel: +852 2428 8008

IN – India, Mumbai

Tel: +91 22 6513 7081-85

JP – Japan, Tokyo

Tel: +81 (0)3 6408 3901

KR – South Korea, Seoul

Tel: +82 2 559 0400

MY – Malaysia, Shah Alam

Tel: +60 3 7849 0800

NZ – New Zealand, Mt Wellington

Tel: +64 9 574 1744

SG – Singapore

Tel: +65 6887 6300

TH – Thailand, Bangkok

Tel: +662 186 7000-99

TW – Taiwan, Taipei

Tel: +886 2 2298 8987

South America

AR – Argentina, Buenos Aires

Tel: +54 3327 44 4129

BR – Brazil, Sao Jose dos Campos

Tel: +55 800 727 5374

CL – Chile, Santiago

Tel: +56 2 623 1216

MX – Mexico, Apodaca

Tel: +52 81 8156 6000

We reserve the right to make technical changes. The data correspond to the technical state at the time of printing.
© 2012 Parker Hannifin Corporation.
All rights reserved.

192-141200N6

September 2012



EMEA Product Information Centre

Free phone: 00 800 27 27 5374

(from AT, BE, CH, CZ, DE, DK, EE, ES, FI, FR, IE, IL,
IS, IT, LU, MT, NL, NO, PL, PT, RU, SE, SK, UK, ZA)

US Product Information Centre

Toll-free number: 1-800-27 27 537

www.parker.com

Your local authorized Parker distributor